



Experimental and Theoretical Analysis of a Novel Flexible Membrane Tactile Sensor

¹Goldis Darb Emamieh, ²Ahmad Ameri, ¹Siamak Najarian, ¹Ali Tavakoli Golpaygani
¹Artificial Tactile Sensing and Robotic Surgery Lab, Faculty of Biomedical Engineering,
Amirkabir University of Technology (Tehran Polytechnic), Tehran, Iran
²Faculty of Health, Medical Sciences University of Iran, Tehran, Iran

Abstract: In this study, we report the development of a new multi tactile sensor, capable of detecting 2D surface texture image, measuring contact-force, and identifying the difference between stiffness of sensed objects. The designed tactile sensor consists of a chamber and a membrane with a mesa structure. The detecting principle is a combination of membrane deflection and piezoresistance effects. A major advantage of the designed system is that it can be easily miniaturized and micromachined. As a result, it is suitable for using in medical applications, especially in minimally invasive surgery (MIS).

Keywords: Tactile sensor, Contact force, Stiffness, Membrane

INTRODUCTION

In living organisms, the physiological senses involving vision, hearing, touch, taste, and smell utilize transducer systems to enable the conversion of detected information to appropriate electrical output. While a great deal of research has been applied to the development of visual and auditory sensors, comparatively, little progress has been made with regard to artificial sensors translating touch^[1]. Tactile sensors are devices which measure the parameters of a contact between the sensor and an object^[2]. Several types of tactile sensors have already been proposed in robotics and automation systems. Also, they can be used in different biomedical engineering and medical robotics applications to sense a wide range of stimuli. This includes detecting the presence or absence of a grasped tissue/object or even mapping a complete tactile image as elastography of an object^[3-5].

Normally, in order to improve the efficiency of these types of sensors, an array of sensors is utilized^[6, 7]. Force and position signatures are the two factors that can provide a great deal of information about the state of gripping or manipulation of a biological tissue^[8]. A medical example can be found in the ability of the human hand to measure the contact-force and the stiffness variations when touching stiff muscles, soft tissues or tumors. Also, human hand is capable of gripping and handling fragile or soft objects without damaging them. Thus, the necessity to sense the contact-force and mechanical properties of objects such as stiffness has particular importance in medical

applications of the robotic hand in general and the development of surgical robot or telesurgery systems. It has been demonstrated that automation technology with artificial sensory can assist surgeons in minimal access treatment by enabling the benefits of steady tool motion through difficult access^[3,5,9].

Minimally invasive surgery (MIS) is now being widely used as one of the most preferred choices for various types of operations^[10-12]. MIS has many advantages, including reducing trauma, alleviating pain, requiring smaller incisions, faster recovery time and reducing post-operation complications^[13,14]. However, MIS decreases the tactile sensory perception of the surgeon. This effect is more pronounced during grasping or manipulation of biological tissues (i.e., veins, arteries, bones, etc.). In this regard, measuring the magnitude of the applied forces, applied by the surgeon through the endoscopic graspers, results in safer handling of biological tissues^[15]. Controlled manipulation tasks are among the maneuvers in which the ability to feel the tissues are very crucial^[16]. The need to detect various tactile properties (such as stiffness, temperature, and surface texture) justifies the key role of tactile sensing which is currently missing in MIS^[1, 17, 18].

Below the most recent advances in application of tactile sensors in medical industries, especially for detecting the stiffness of biological tissues, will be presented.

Stiffness is an important parameter in determining the physical properties of living tissues. Considerable

Corresponding Author: Full-Professor of Biomedical Engineering, Department of Biomechanics, Artificial Tactile Sensing and Robotic Surgery Lab, Faculty of Biomedical Engineering, Amirkabir University of Technology, Tehran, Iran, P.O. Box 15875-4413. Tel: (+98-21)-6454-2378. Fax: (+98-21)-6646-8186

biomedical attention has centered on the mechanical properties of living tissues at the single cell level. The Young's modulus of zona pellucida of bovine ovum was calculated using micro-tactile sensor fabricated and PZT material^[19]. The stiffness of the cartilage of the human femoral condyles was measured via an ultrasonic tactile sensor under arthroscopic control^[20]. The tactile sensor was useful for determining the intraoperative stiffness of healthy and diseased human cartilage in all grades. This research work describes an approach of studying the dynamic, information rich, molecular structure of the ultimate smart interface, i.e., human skin, by coupling the advances in biological, microsystems, and information technology. The development of milli-robotic tools for remote, MIS, is reported. It describes the limitations of current surgical practice and the technological and scientific issues involved in building a telesurgical workstation^[21]. A new tactile sensor system has been developed for accurate measurement of myocardial stiffness in situ^[22]. Piezoresistive sensors, applied to the fingertips of nonsensate fingers, were used for the detection of touch and pressure in four patients with recent median nerve repairs, and in one patient using a myoelectric prosthesis^[23]. The design, fabrication, testing, and mathematical modeling of a semiconductor microstrain gauge endoscopic tactile sensor have been investigated^[24]. The sensor can measure, with reasonable accuracy, the magnitude and the position of an applied load on the grasper.

In this paper, we propose a new type of tactile sensor that can detect both the contact-force and the stiffness of an object. The major advantage of the system proposed in this paper is the simplicity and robustness of the design.

MATERIALS AND METHODS

Sensed Objects: In tactile sensing, a force range of 0.1N to 10N considered to have practical applications in medical devices^[24]. Also, a review of related literature shows that the variations of compliance and stiffness are quite large in different biological tissues. For instance, the Young's modulus of elasticity is about 0.11 MPa for the pig spleen, while it is about 4.0 MPa for the pig liver. The same conclusion describes the case for human tissues^[25].

2D Surface Texture Image Detection: Figure 1 shows an array of two elements of our tactile sensor. When the tactile sensor array comes in contact with an object that has a bumpy surface, some of the mesa structures on

the membrane push inwards and as a result of it, the system can detect the presence or absence of object above each of elements. So, we can save a 2D surface texture image of the object.

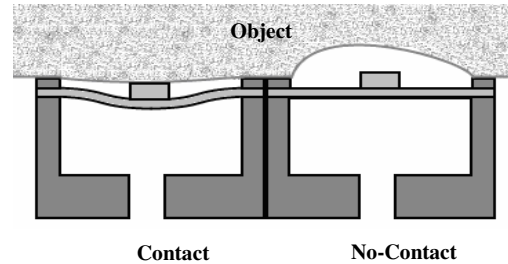

Fig. 1: An array of two elements for detecting contact-force distribution and surface texture image.

Contact-Force Estimation: The structure of the estimating contact-force is also shown in Fig. 1. When the mesa of membrane comes in contact with an object, the normal force or uniform pressure from it causes inward deformation of the membrane. Therefore, by determining the displacement at the center of the membrane and according to the mechanical properties of it, we can measure the amount of normal force or the uniform pressure actuating on it.

Stiffness Detection: In this mode, the contacting mesa elements are pneumatically driven against the object (Fig. 2).

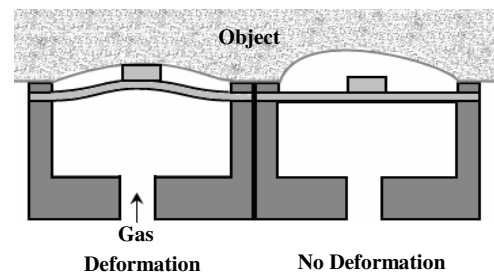

Fig. 2: A schematic of the tactile sensor for detecting stiffness distribution.

The contact regions of the object are deformed according to the driving force of the mesa element and the stiffness of the object. Therefore, we can detect the stiffness of the object by measuring the relationship between the deflection of the membrane and the actuation force of it.

The operation of the tactile sensor has been analyzed theoretically and numerically and their results are compared with the experimental results.

Device Specification: The device has a cylindrical shape and as a result, it caused to simplify the problem and reduce the amount of calculation. The radius of membrane is 2 cm and it is attached on a rigid cylinder which has a port for gas supply and exhaust. The thickness of membrane is 100 μm and the radius of mesa is 0.5 cm with a thickness about 150 μm. Table 1 shows typical specifications of the sensor element.

Table 1: Specifications of the modeled sensor

2 cm (inner radius)	Device(cylindrical)
3 cm (outer radius)	
5 cm (height)	
2 cm (radius)	Membrane
100 μm (thickness)	
0.5 cm (radius)	Mesa
150 μm (thickness)	
0.33	ν (Poisson's ratio)
30 MPa	E (Elastic modulus)

Theoretical Analysis: The problem of axisymmetric large deformation of circular membrane has practical significance. From the large deformation theory of a clamped single-layer circular membrane under the concentrated force (Fig. 3), the solution for out-of-plane deflections (OPD) can be expressed as^[26]:

$$\left(\frac{w_0}{h}\right)^3 = \left[1 - \left(\frac{1-3\nu}{4}\right)^{1/3}\right]^3 \frac{4R^2}{(1+\nu)\pi Eh^4} F \quad (1)$$

where w_0 is out-of-plane deflection of membrane, R is radius of membrane, h is thickness of membrane, ν is Poisson's ratio, E is elastic modulus and F is applied force at central point.

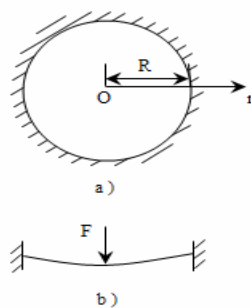

Fig. 3: Theoretical model. a) Front view, b) Top view

We analyzed the tactile sensor theoretically for determining the stiffness of an object and assumed that the membrane and contacted object are elastic materials. So, we modeled the membrane and the

contacted object with two springs, under a concentrated force.

Numerical Analysis: Numerical tests have been performed to simulate the mechanical responses of the proposed tactile sensor. For finite element modeling of the sensor, commercial finite element analysis software package (ANSYS, version 10.0) was employed.

Experimental Method: For research in biological and physiological areas, accurate measurement of tissue mechanical properties is required, but on-line monitoring is not strictly necessary. In most medical devices, especially in diagnostic instruments (e.g., the identification of abnormality in the mechanical properties of an organ or tissue such as stiffness) we require an instrument, which should be able to provide the information in real time, even if it is less accurate^[24].

A single tactile sensor was fabricated according to the theoretical model specification. The material of membrane should yield sufficiently under low force, in an ideal elastic (no hysteresis) and repeatable manner.

Several polymers were studied to identify one with suitable mechanical properties and more compatibility with the biological tissues. Materials with the high hysteresis were rejected. We made the body of sensor (substrate of membrane) of PVC because of rigid functionality and low cost of it. We chose a particular kind of silicon rubber as the membrane. Also, we selected some different types of silicon rubber with different hardness for the samples to test the second section of tactile sensor experiment.

Samples with great stiffness, less stiffness, and the same as membrane stiffness were selected. Table 2 demonstrates some mechanical properties of membrane and samples.

Table 2: Specification of membrane and samples

Material	ID	Hardness	Young's modulus (MPa)
Si rubber	M4600 A/B	A20	0.77
Si rubber	M4670 A/B	A55	3.75
Si rubber	M4670/1 A/B	A30	1.07
Polyurethane		D70	548

Shapes of the samples were rectangular and were fabricated by using molding technology. We embedded a single strain gauge in membrane, exactly in peripheral and radius directions of membrane.

The strain gauge is one of the most important tools of the electrical measurement techniques applied to the measurement of mechanical quantities. There are many advantages for using strain gauges. They can achieve an overall accuracy of better than $\pm 0.1\%$. They are relatively inexpensive, available in a short gage length, and are only moderately affected by temperature changes. They have small physical size and low mass, and are highly sensitive.

The embedded strain gauge (Tokyo Sokki Kenkyujo, 120 Ω , FLA-10-11) on the membrane is connected into a Wheatstone bridge circuit with a combination of a single strain gauge (quarter bridge).

Axisymmetric shape of the sensor is useful for simplifying, and reducing the number of bonded strain gauge to only one. The bridge is excited with a stabilized DC power supply. Figure 4 shows a diagram of Wheatstone bridge and amplifying circuit.

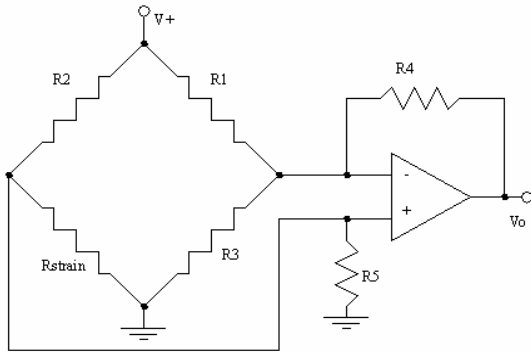

Fig. 4: Wheatstone bridge circuit with amplifiers

As we applied force to the center of the membrane, the embedded strain gauge measured the strain in the membrane due to membrane stretching. As a result of membrane deflection and so on applying stress on strain gauge, resistive changes take place and unbalance the Wheatstone bridge. This results in a signal output, related to the stress value because of membrane deflections. The signal value is small (a few millivolts), so an amplifying circuit is used to increase the signal, and change it into a suitable level for application and measurement. The details of the experimental setup for two experiments are represented in Fig. 5 and Fig. 6.

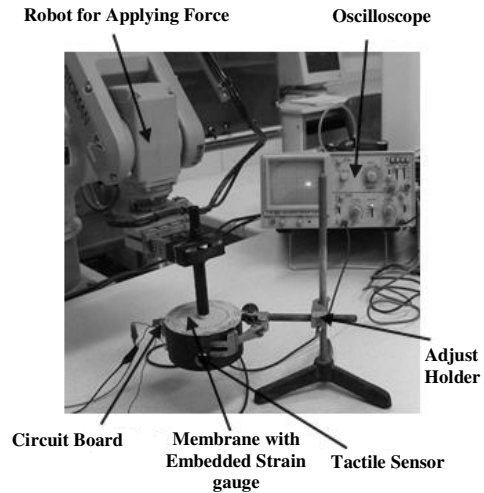

Fig. 5: The first experimental setup

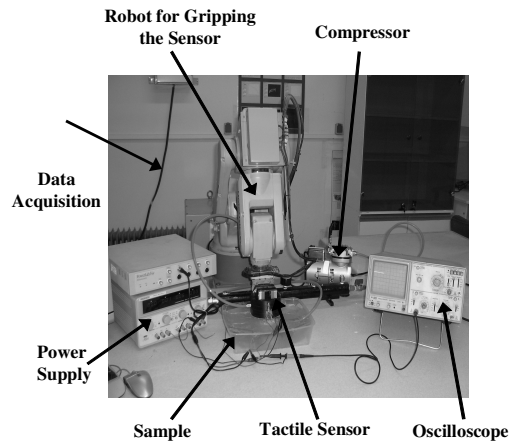

Fig. 6: The second experimental setup

An oscilloscope was used to measure the signal output. Additionally, a PC data acquisition was used for collecting data and drawing the graph of output signal variations. The proposed tactile sensor can be used to measure both static and dynamic force and it is suitable for a wide variety of environmental conditions. As can be seen in Fig. 5, in the first experiment, a cylindrical probe driven by a robot hand (MOTOMAN, Yaskawa, Japan, 6 degrees of freedom) was used to apply a static force with a precise deflection on membrane of the tactile sensor. In another experimental setup, for determining the contact-force, static forces were applied to the sensor using steel weights and the output from the strain gauge was recorded. Loads were applied incrementally to nearly 1N and then they were unloaded. As shown in Fig. 6, we used a compressor

and accessory equipment (the needle valve, pressure gauge, and pipe) for the second experimental setup and in order to estimate the stiffness of fabricated samples.

RESULTS AND DISCUSSION

We analyzed the proposed sensor, theoretically and numerically and there was a good agreement between those results^[27].

Figure 7 shows the measured output voltage of the strain gauge versus the applied force to the membrane and Figure 8 shows the measure output voltage of the strain gauge versus the deflection at the center of the membrane.

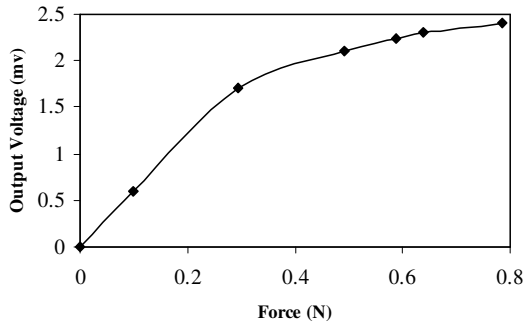

Fig. 7: Output voltage vs. the applied force

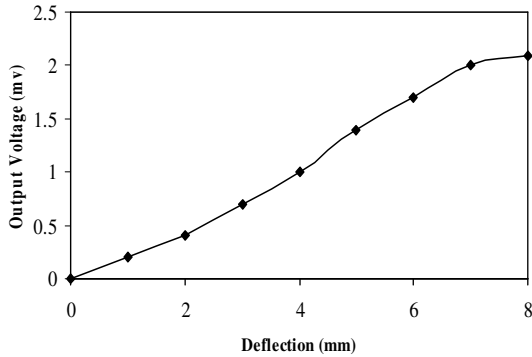

Fig. 8: Output voltage vs. the out-of-plane deflection

Additionally, we investigated the changes of the membrane deflection in contact with different materials and obtained the following results:

- a) If the elasticity of the object is much smaller than the elasticity of the membrane, the sensor cannot sense the stiffness of the object and the variations of it.
- b) If the elasticity of the object is too large compared to the membrane, the deflection of the membrane is very

small and with increasing the stiffness of object, the amount of deflection declines to zero. As a result, in this region, the membrane of the sensor cannot be deformed and the sensor cannot detect the stiffness or changes of it.

c) If the mechanical properties of object are similar to those of the membrane, the amount of deflection of membrane is related to stiffness of the object and this amount changes with the variations of stiffness. As a result, in this region, the sensor can detect the stiffness of the object according to the membrane deflection, against the amount of deflection in the same condition when membrane does not have any contact with the object.

We conclude that in order to detect a change in the stiffness of the touched object, the elasticity of the touched object should be almost the same as that of the touched object.

Figure 9 shows the measured output voltage of the electronic circuit of sensor versus the gas pressure applied to membrane in no contact and contact with different samples. The output voltage in all cases drastically increased with increasing gas pressure.

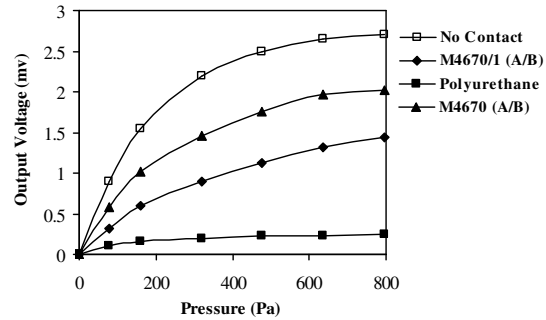

Fig. 9: Variations of output voltage at different gas pressures

According to Fig. 9, the amount of deflection of membrane in contact with the stiffer objects at unique pressure is less than that of the other. So, with moving the sensor on an identified area at a constant pressure, the changing of membrane deflection and hence the output voltage of sensor describes the changing of surface stiffness of that area.

According to these continuous results from the sensor, we can have an elastography or map the difference in stiffness on the path of sensor moving.

CONCLUSION

We successfully developed a new multifunctional tactile sensor based on the principle of membrane

deflection and piezoresistance effect. The result of the present study demonstrated that the new tactile sensor is capable of measuring the contact-force and detecting stiffness of soft objects. In conclusion, this tactile sensor has the following characteristics:

- 1) Mechanical flexibility and robustness.
- 2) Very good sensitivity and high measurement range with less changing.
- 3) This sensor uses common materials and can be easily constructed in laboratories at very low cost.
- 4) The electronic circuit is very simple and does not require any expensive measurement system.

The above characteristics have great advantages in applying this tactile sensor not only in research applications but also in industrial and clinical use. For example, in biomedical applications, especially in MIS, this sensor is useful for detecting the difference in stiffness between intact normal and diseased soft tissues.

ACKNOWLEDGEMENTS

This work was partially supported by the grant awarded by The Ministry of Health of Iran through Razi International Festival. The authors wish to thank The Ministry of Health for their support. We also would like to express our gratitude to the Center of Excellence of Biomedical Engineering of Iran based in Amirkabir University of technology, Faculty of Biomedical Engineering for its contribution.

REFERENCES

1. Dario, P., 1991. Tactile Sensing-Technology and Applications. *Sensors and Actuators A-Physical*, 26: 251-261.
2. Lee, M.H., H.R. Nicholls, 1999. Tactile Sensing for Mechatronics—a State-of-the-Art Survey. *Mechatronics*, 9: 1-31.
3. Najarian, S., J. Dargahi and X.Z. Zheng, 2006. A Novel Method in Measuring the Stiffness of Sensed Objects with Applications for Biomedical Robotic Systems. *Int. J. Med. Robotics Comput. Assist. Sur.*, 2: 84-90.
4. Singh, H., J. Dargahi and R. Sedaghati, 2003. Experimental and Finite Element Analysis of an Endoscopic Tooth-Like Tactile Sensor. 2nd IEEE International Conference on Sensors, Toronto, Canada.
5. Dargahi, J., 2002. An Endoscopic and Robotic Tooth-Like Compliance and Roughness Tactile Sensor. *J. Mech. Design*, 124: 576-582.
6. Fisch, A., C. Mavroidis, J. Melli-Huber and Y. Bar-Cohen, 2003. *Biologically Inspired Intelligent Robots*. SPIE Press: Bellingham, Washington.
7. Dargahi, J., S. Najarian, 2004. Human Tactile Perception as a Standard for Artificial Tactile Sensing: A Review. *Int. J. Med. Robotics Comput. Assist. Surg.*, 1(13): 23-35.
8. Rininsland, H.H., 1993. *Basics of Robotics and Manipulators in Endoscopic Surgery*. *Endoscop. Surg. Allied. Technol.*, 1: 154-159.
9. Dargahi, J., S. Najarian, 2005. Advances in Tactile Sensors Design/Manufacturing and its Impact on Robotics Applications—A Review. *Industrial Robot*, 32: 268-281.
10. Rao, N.P., J. Dargahi, M. Kahrizi and S. Prasad, 2003. Design and Fabrication of a Microtactile Sensor. Canadian Conference on Electrical and Computer Engineering Towards a Caring and Human Technology, Montreal, Canada.
11. Dargahi, J., S. Najarian, 2004. An Integrated Force-Position Tactile Sensor for Improving Diagnostic and Therapeutic Endoscopic Surgery. *BioMed. Mater.*, 14: 151-166.
12. Dargahi, J., M. Parameswaran and S. Payandeh, 2000. A Micromachined Piezoelectric Tactile Sensor for an Endoscopic Grasper: Theory, Fabrication, and Experiments. *J. Microelectromechan. Syst.*, 9: 329-335.
13. McGinty, J.B., S.S. Burkhart, R.W. Jackson, et al., 2002. *Operative Arthroscopy*. Lippincott Williams & Wilkins: Philadelphia.
14. Dargahi, J., S. Najarian, 2004. Analysis of a Membrane Type Polymeric-Based Tactile Sensor for Biomedical and Medical Robotic Applications. *Sensors & Materials*, 16: 25-41.
15. Gray, B., R.S. Fearing, 1996. A Surface Micromachined Microtactile Sensor Array. *Proceedings of IEEE International Conference on Robotics and Automation*, Minneapolis, USA. 1-6.
16. Brouwer, I., J. Ustin, L.M. Bentley, et al., 2001. Measuring In Vivo Animal Soft Tissue Properties for Haptic Modeling in Surgical Simulation. *Medicine Meets Virtual Reality*, 81: 69-74.
17. Dargahi, J., 2001. A Study of the Human Hand as an Ideal Tactile Sensor Used in Robotic and Endoscopic Applications. *Proceeding of the CSME International Conference*, Montreal, Canada, 21-22.

18. Howe, R.D., W.J. Peine, D.A. Kontarinis and J.S. Son, 1994. Remote Palpation Technology. *Proc. IEEE Eng. Med. Biol. Mag.*, 14(3): 318-323.
19. Murayama, Y., C.E. Constantinou and S. Omata, 2004. Micromechanical Sensing Platform for the Characterization of the Elastic Properties of the Ovum via Uniaxial Measurement. *Journal of Biomechanics*, 37: 67-72.
20. Uchio, Y., M. Ochi, N. Adachi, K. Kawasaki and J. Iwasa, 2002. Arthroscopic Assessment of Human Cartilage Stiffness of the Femoral Condyles and the Patella with a New Tactile Sensor. *Medical Engineering & Physics.*, 24: 431-435.
21. Sastry, S.S., M. Cohn and F. Tendick, 1997. Milli-Robotics for Remote, Minimally Invasive Surgery. *Robotics and Autonomous Systems*, 21: 305-316.
22. Miyaji, K., S. Sugiura, H. Inaba, S. Takamoto and S. Omata, 2000. Myocardial Tactile Stiffness During Acute Reduction of Coronary Blood Flow. *The Annals of Thoracic Surgery*, 69: 151-155.
23. Lundborg, G., B. Rosen, K. Lindstorm and S. Lindberg, 1998. Artificial Sensibility Based on the Use of the Piezoresistive Sensors, Preliminary Observations. *The Journal of Hand Surgery: Journal of the British Society for Surgery of the Hand*, 23: 620-626.
24. Dargahi, J., S. Najarian, 2004. An Endoscopic Force Position Grasper with Minimum Sensors. *Canadian Journal of Electrical and Computer Engineering*, 28: 151-161.
25. Dargahi, J., S. Najarian, 2005. Measurements and Modeling of Compliance Using a Novel Multi-Sensor Endoscopic Grasper Device. *Sensors and Materials*, 17: 7-20.
26. Shan-lin, C., Z. Zhou-lian, 2003. Large Deformation of Circular Membrane Under the Concentrated Force. *Applied Mathematics and Mechanics*, 24(1): 28-31.
27. Tavakoli Golpaygani, A., S. Najarian, G. Darbemamieh, 2007. Design and Modeling of a New Tactile Sensor Based on Membrane Deflection. *American Journal of Applied Sciences*, 4(10): 813-819.